

Volume of Triangular Prism

ES1

Find the volume of each triangular prism.

1)

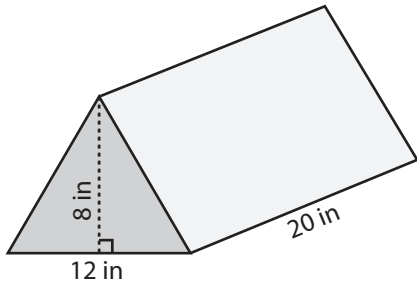

Volume = _____

2)

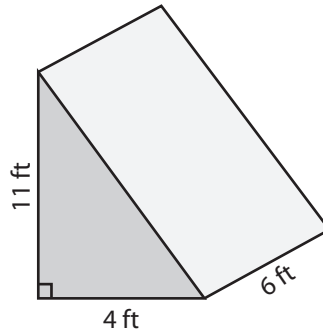

Volume = _____

3)

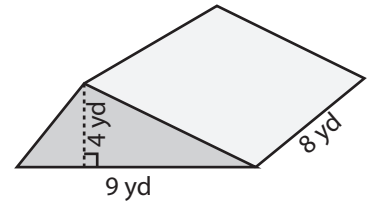

Volume = _____

4)

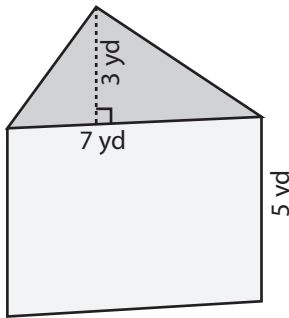

Volume = _____

5)

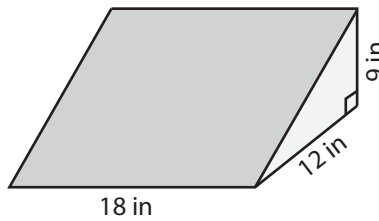

Volume = _____

6)

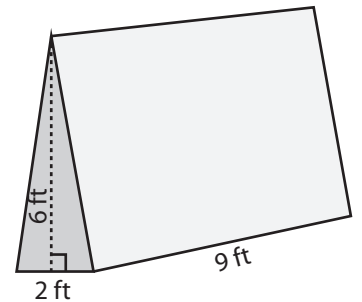

Volume = _____

7)

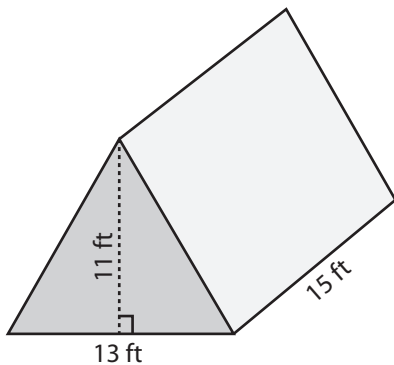

Volume = _____

8)

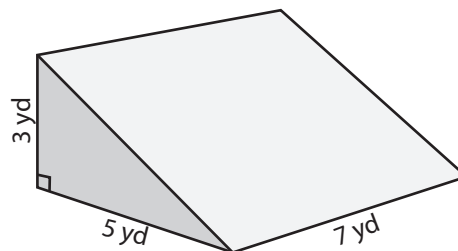

Volume = _____

9)

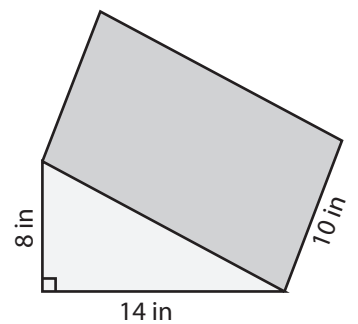

Volume = _____

Name : _____

Score : _____

Answer Key

Volume of Triangular Prism

ES1

Find the volume of each triangular prism.

1)

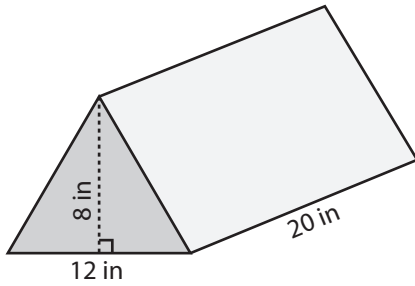

Volume = 960 in³

2)

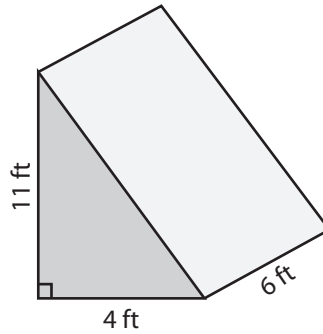

Volume = 132 ft³

3)

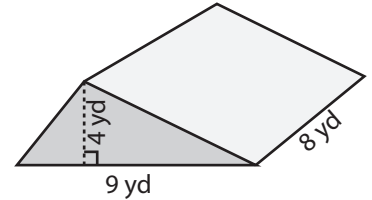

Volume = 144 yd³

4)

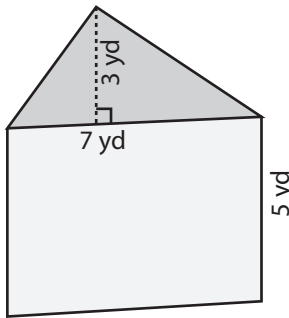

Volume = 52.5 yd³

5)

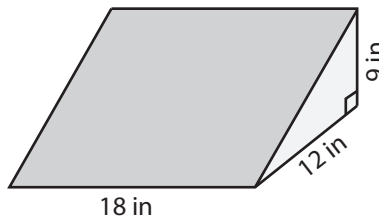

Volume = 972 in³

6)

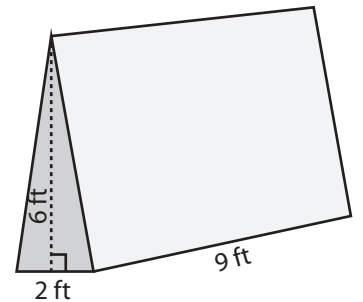

Volume = 54 ft³

7)

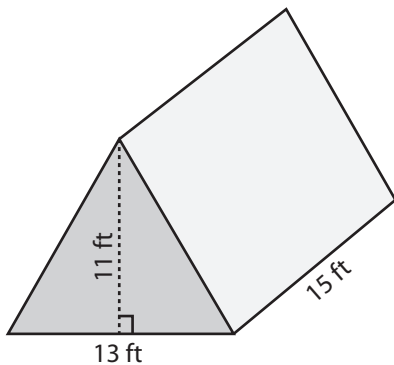

Volume = 1072.5 ft³

8)

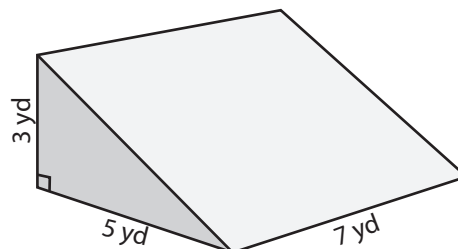

Volume = 52.5 yd³

9)

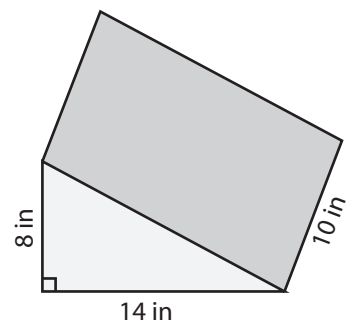

Volume = 560 in³